

Configuration						
Dash #	Assy, TA360		Dash #	Assy, TA360		USB Connector
NON LIGHTED		LIGHTED				
6430360-1	-1	9019342-1	6430360-11	-11	9019342-1	Type A, C
6430360-3	-3	9019342-1	6430360-13	-13	9019342-1	Type C, C
6430360-7	-7	9019342-1	6430360-17	-17	9019342-1	Type C
6430360-21	-21	9019342-2	6430360-31	-31	9019342-2	Type A, C 100W
6430360-27	-27	9019342-2	6430360-37	-37	9019342-2	Type C 100W

Revision				
ECO	Rev.	Description	Date	Approved
	A	Production release.	10/10/19	VAA/BAW
7491	B	Added -21, -27, -31 and -37 configuration and updated specification table.	06/03/22	VAA/MEK
7515	C	Updated weights in specification table for single and A/C unit.	07/18/22	VAA/MKN

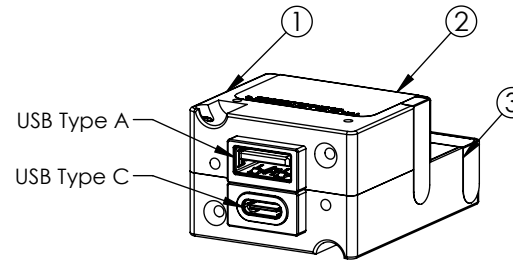

Config -1,11, 21, 31

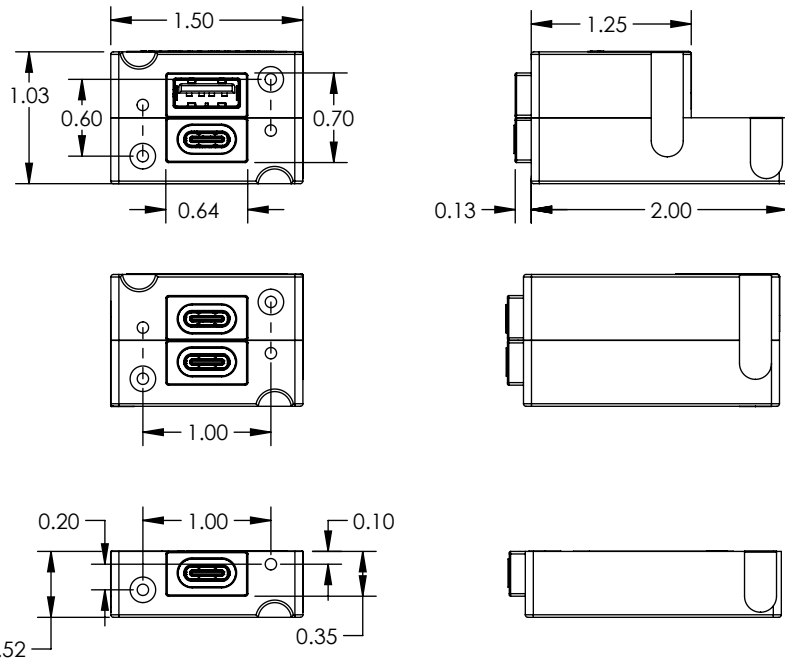
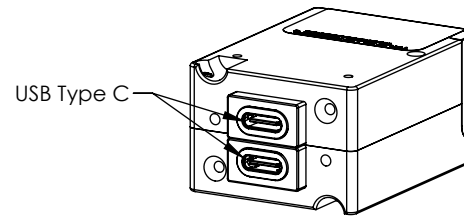

Config -3,13

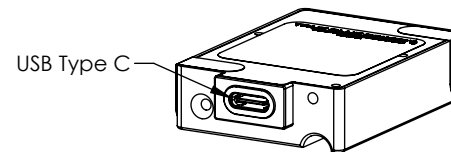

Config -7,17, 27, 37

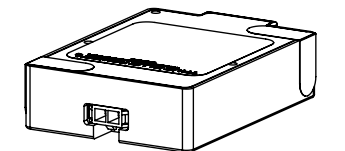
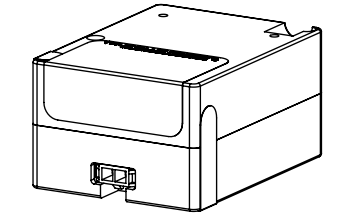
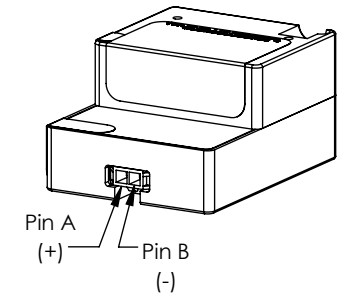

Specifications			
Model Number	TA360		
Interface	USB Type-A	USB Type-C	USB Type C 100W
Voltage - Input	22 - 32 VDC		
Voltage - Output	5.0±.25	Auto Adjusting 5, 9, 15, 20	
Power- Input/Output	18/15W	66/60W	104/97W
Standard	USB Battery Charging BC 1.2	USB Power Delivery Spec 3.0	
	Qualification	FAA TSO-C71 RTCA DO-160G (See Installation Manual)	
Case	Anodized Aluminum, Black		
Mating Connector Kit	P/N 9017960		
Weight	1.3 oz (37g)-single port, 1.9 oz (54g)-dual A/C port; 2.5 oz (71g)-dual C ports		
Installation Manual	P/N 9019411		

Connector Pinout	
A	22-32 VDC Input
B	Ground

UNLESS OTHERWISE SPECIFIED, ALL DIMENSIONS ARE IN INCHES.
TOLERANCE:
.X= ±0.065
.XX= ±0.015
.XXX= ±0.005
.XXXX= ±0.002
ANGULAR= ±0.5°
WEIGHT N.T.E. +5%
BREAK ALL SHARP EDGES
THREADS PER MIL-S-7742

DRAWN:
VAA
3/22/2019

APPROVED:
BAW
10/10/2019

This document discloses proprietary information of Mid-Continent Instrument Co., Inc. It may be reproduced or disclosed only with written permission of Mid-Continent Instrument Co. and is not to be used in any way detrimental to the interests of Mid-Continent Instrument Co., Inc.

TITLE:
USB Power Delivery Charging Port

SCALE: NONE DO NOT SCALE THIS DRAWING

PART NUMBER:
6430360

SHEET: 1 of 1

Item	Qty	Part Number	Description
1	1	9019366-()	Assy, TA360 (See Config)
2	1	See config	Nameplate, TA360
3	2	6018956-1	Decal, Warranty

