

## DHM-1 Hour Meter

### Specifications

Display Reading	0 ~ 99,999.9 Hours (Automatically recycle to zero)
Digit Height	7mm
Operating Voltage	8-80V DC
Resolution	0.1 hour
Storage Temperature	-40° to +85°C
Operating Temperature	-40° to +85°C
Humidity	95% (without ice formation)



### Dimensions:

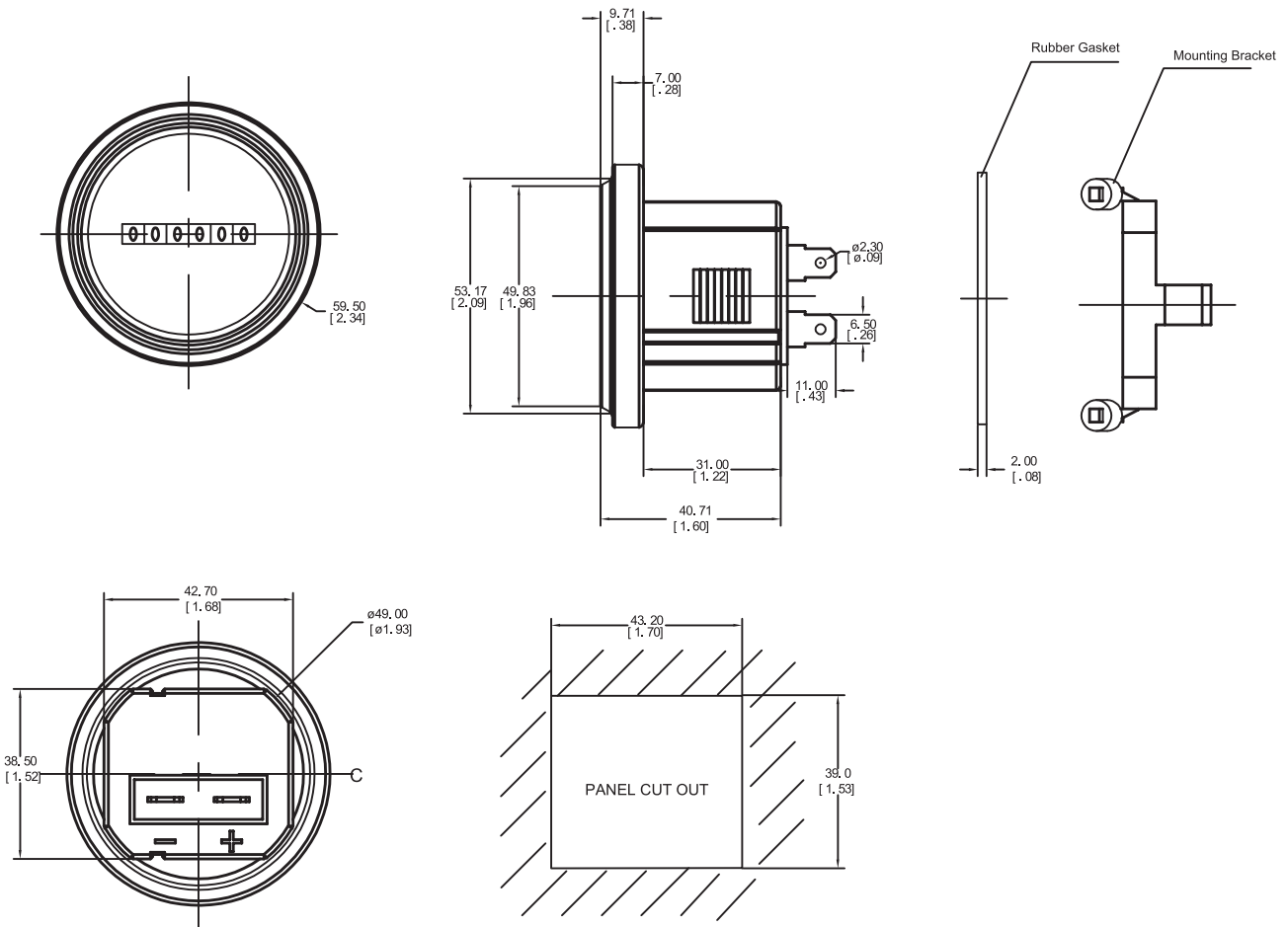

## DHM-2 Hour Meter

### Specifications

Display Reading	0 ~ 9,999.9 Hours (Automatically recycle to zero)
Digit Height	7mm
Operating Voltage	12-40V DC
Resolution	0.1 hour
Storage Temperature	-40° to +85°C
Operating Temperature	-40° to +85°C
Humidity	95% (without ice formation)



### Dimensions:

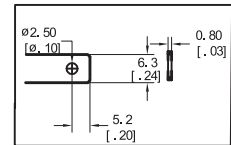
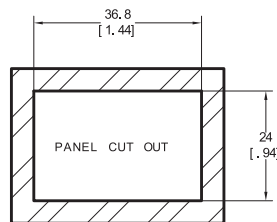
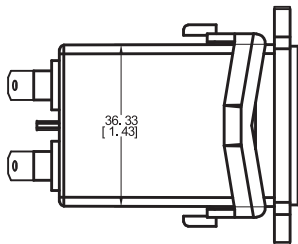
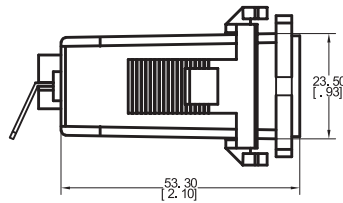
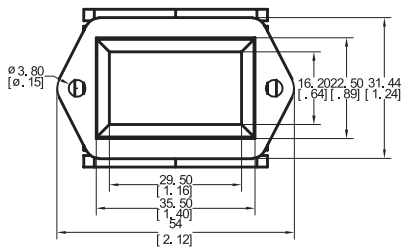

Dimensions for Connectors

## DHM-2N Hour Meter (IP65)

### Specifications

Display Reading	0 ~ 99,999.9 Hours (Automatically recycle to zero)
Digit Height	3mm
Operating Voltage	8-80VAC/DC
Resolution	0.1 hour
Storage Temperature	-40° to +85°C
Operating Temperature	-20° to +65°C
Humidity	95% (without ice formation)



### Dimensions:

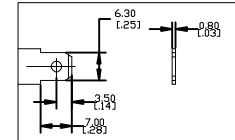
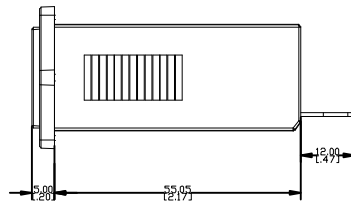
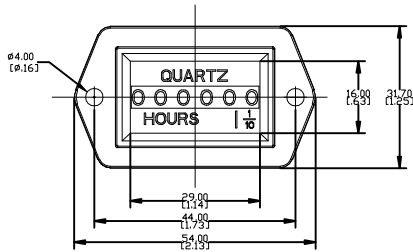

Dimensions for Connectors

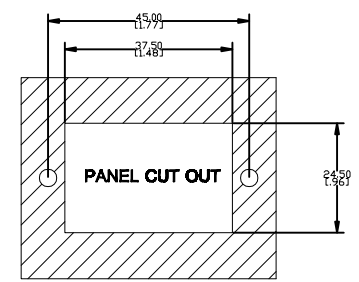
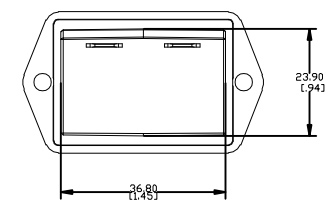
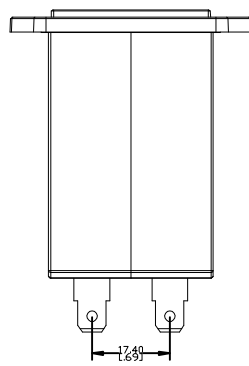

## DHM-3 Hour Meter

### Specifications

Display Reading	0 ~ 99,999.9 Hours (Automatically recycle to zero)
Digit Height	7mm
Operating Voltage	6-80V DC
Resolution	0.1 hour
Storage Temperature	-40° to +85°C
Operating Temperature	-40° to +85°C
Humidity	95% (without ice formation)



### Dimensions:

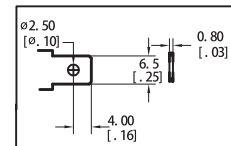
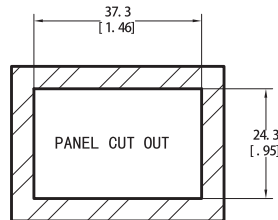
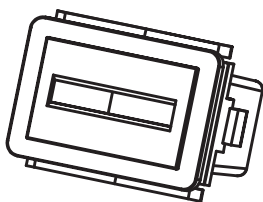
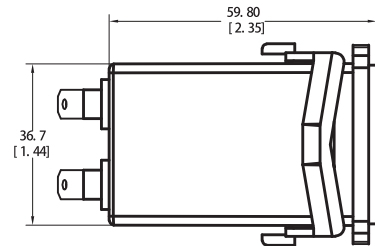
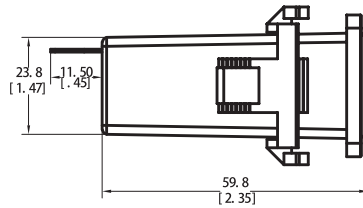
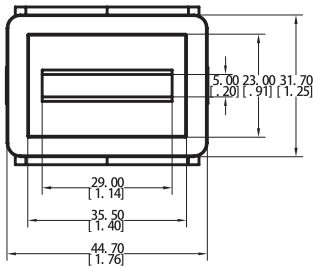

Dimensions for Connectors

## DHM-4 LCD Digital Hour Meter

### Specifications

Display Reading	0.0 ~ 99,999.9 Hours (Automatically recycle to zero)
Digit Height	7mm
Data Storage	CMOS (EEPROM)
Operating Voltage	5-277V AC/DC
Resolution	0.1 hour
Storage Temperature	-40° to +85°C
Operating Temperature	-40° to +85°C
Humidity	95% (without ice formation)



### Dimensions:

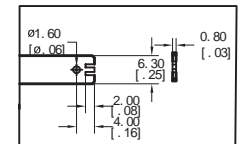
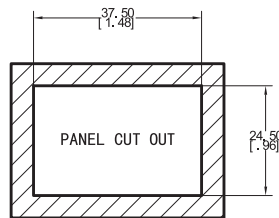
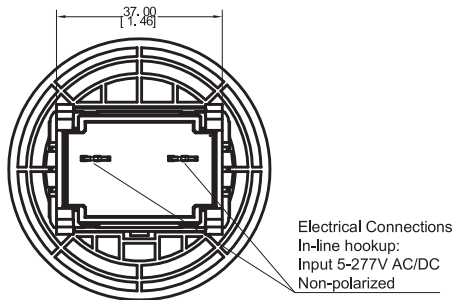
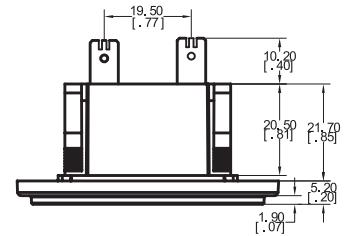
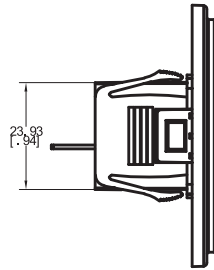
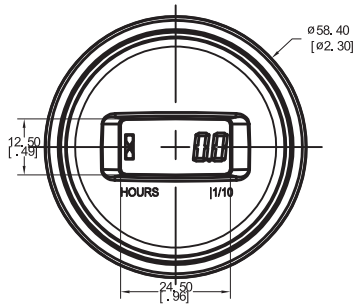

Dimensions for Connectors

## DHM-5 LCD Digital Hour Meter

### Specifications

Display Reading	0.0 ~ 99,999.9 Hours (Automatically recycle to zero)
Digit Height	7mm
Data Storage	CMOS (EEPROM)
Operating Voltage	4.5-60V AC/DC
Resolution	0.1 hour
Storage Temperature	-40° to +85°C
Operating Temperature	-40° to +85°C
Humidity	95% (without ice formation)
IP Rating	IP68



### Dimensions:

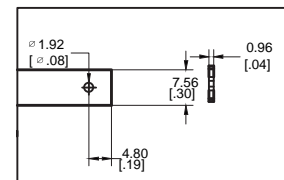
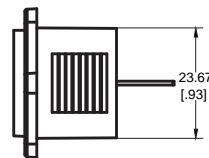
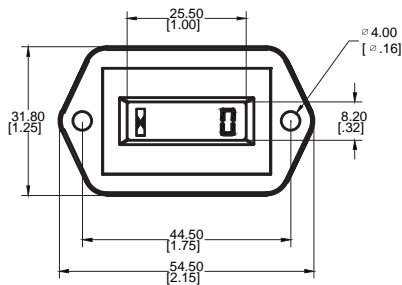

Dimensions for Connectors

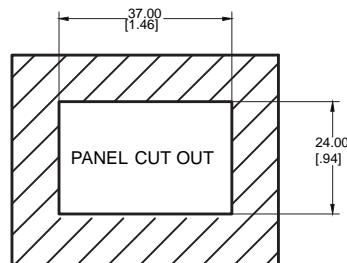
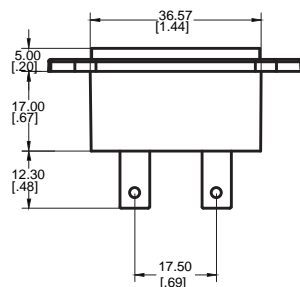

## DHM-6 LCD Digital Hour Meter

### Specifications

Display Reading	0.0 ~ 99,999.9 Hours (Automatically recycle to zero)
Digit Height	7mm
Data Storage	CMOS (EEPROM)
Operating Voltage	4.5-60V AC/DC
Resolution	0.1 hour
Storage Temperature	-40° to +85°C
Operating Temperature	-40° to +85°C
Humidity	95% (without ice formation)
IP Rating	IP68



### Dimensions:

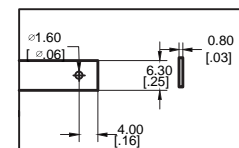
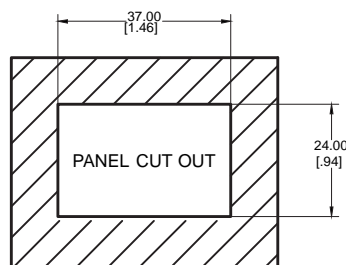
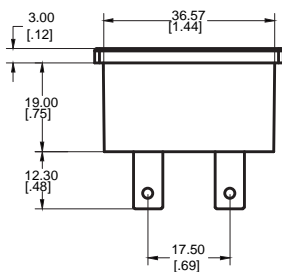
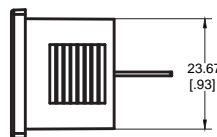
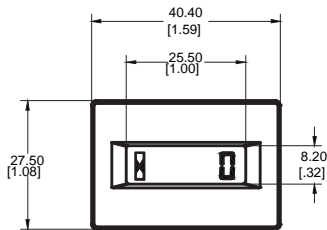

Dimensions for Connectors