

Aircraft Extras Inc.

Flap Positioning System with Elevator Trim Compensation

FPS-Plus



- * FULL AUTOMATIC FLAP POSITIONING, with
- * AUTOMATIC ELEVATOR TRIM COMPENSATION
- * 4 MODES of OPERATION, (STEP & PROPORTIONAL MODES)
- * OPERATES ON +12V & +24V SYSTEMS
- * COMPATIBLE WITH MOST MOTORS & INDICATORS
- * Set-Up is FULLY USER PROGRAMMABLE!
- * ONE BUTTON PROGRAMMING
- * NO LIMIT SWITCHES TO INSTALL

What is the FPS-Plus?

The FPS-Plus is a full service, automatic, flap positioning system, . . . Plus! In the fully automatic step position mode, a "one button touch", commands the flaps and elevator trim to move. One touch moves the flap from programmed flap stop, to programmed flap stop. Holding the flap button down for more than 1 second commands the flaps to go to either the full up, or the full down position. The FPS-Plus is fully user programmable up to 10 flap positions. PLEASE read on about the "PLUS" feature.

The "Plus" feature and Pitch Stability

Have you ever wondered what it would be like to adjust your flaps without the nose of your aircraft pitching up or down? Perfect pitch stability is a very desirable flight characteristic that many small planes do not have. After adjusting the flaps, most pilots compensate for the pitch up or down by manually cranking in a bit of elevator trim. We have all done it. With the FPS-Plus, your aircraft can perform like the larger, more expensive aircraft with good pitch stability. Your elevator trim will be automatically adjusted for every different flap setting that you command. Using the FPS-Plus allows you to lower your flaps, and your aircraft will simply slow down without a significant change to your aircraft's present glide path.

"FINALLY! , . . No more manual tweaking on final approach to relieve your stick back pressure!"

Elevator Trim Compensation Advantages

"Aborted landings"

"Touch & goes"

and "Slow Flight", . . . are all made much easier without stick back pressure.

With the FPS-Plus, the pilot can pay more attention to "flying the aircraft", rather than adjusting the correct amount of elevator trim for every different flap setting. If the pilot desires, he/she may manually adjust the elevator trim after the automatic adjustment of the FPS-Plus has finished.

What if my aircraft weight & balance changes?

The FPS-Plus was designed so that it is very easy for the pilot to store a new elevator trim position during flight, by simply pressing one button. While this feature of the FPS-Plus is not needed for most two seat aircraft, it may be desired for aircraft of 4 seats or more if the aircraft balance changes significantly from flight to flight. To readjust the FPS-Plus to a new flight load, for each flap setting, simply adjust your elevator trim manually, then press the programming button. A new elevator trim position will be stored for that flap position. The FPS-Plus will automatically adjust the elevator trim for each flap setting thereafter. **NOTE:** (Aircraft flight loads need to change significantly before the pilot needs to put in new elevator trim values.)

SPECIFICATIONS:

The system will operate on +12Vdc or +24Vdc

Dimensions: 3"x5"x1.25", Footprint: 3"x5.75"

Weight: < 8oz.

Maximum amperage for each servo motor, 10A.

Mounting: 2 holes, 0.156" dia, 5.375" apart.

Will operate with existing sensors, motors & indicators for retrofits

(FPS-Plus-nt, same standard features without elev. trim compensation)

Additional Information for the FPS-Plus and FPS-Plus-nt

What do you need to complete the installation?

You Need:

- 1.) an Automatic Flap Switch
- 2.) a Position Sensor
- 3.) a Manual Flap Switch (optional, see explanation below)
- 4.) an ON/OFF Switch (optional, see explanation below)

The explanation below is a little “wordy”, but it will clear up a lot of application questions that are occasionally asked by all of you great builders. Some of you have a good electrical background, some do not. Please also refer to our “Switching Options Diagram” for more details if you are unfamiliar with switch and relay terminology.

We do not include:

We do not include position sensors and switches with the FPS-Plus or the FPS-Plus-nt. The reason for this is simple. Most people want to use their own switches, and some people already have purchased their position sensors along with their position indicators. This being the case, for those of you that haven’t made the purchase yet, here is a quick summary of what you need to complete this system and how to choose your parts.

You need an Automatic Flap Switch

Switch Location

First, a bit of **CAUTION**. We do not recommend that you use the stick grip switch to drive the FPS-Plus's automatic flap input. The reason for this is simple. The Stick Grip switches may be easy to bump during flight. If you bump your stick grip switch, it will cause the FPS to automatically move the flaps to the next flap position. This may not be what you really want to do at a high cruise speed, landing, or take off. For safety, we recommend that the "automatic flap switch" for the FPS-Plus only be installed on your instrument panel, and in a place where it cannot be accidentally bumped.

Switch Type

This automatic flap switch should be a Single Pole, Double Throw, (ON)-OFF-(ON), momentary, 3 position switch. Refer to SW2 of our “Switching Options Diagram” for more details.

The (ON) stands for “on momentary”, a spring loaded switch.

You can purchase this type of switch most anywhere. The current and voltage rating of the switch does not matter since it switches low voltages and currents.

Compatible Panel Switches

The RayAllen Company’s RS2 and ROS-4 switches are compatible with this switching methodology, however the RS2 switch provides two independent switches inside its housing. You can wire them together to obtain this switching operation. Refer to RayAllen's documentation for details.

Compatible Stick Grips

Both the RayAllen Company and Infinity Aerospace Inc. stick grips are compatible with this switch methodology. Again, the RayAllen stick grip switch is compatible with this switching methodology, however they provide two separate switches inside their stick that you can wire together to obtain this switching operation. Refer to RayAllen's documentation for details.

You need a Manual Flap Switch (OPTIONAL)

The Manual Flap Switch is optional. If you desire to operate your flaps manually, or simply have a back-up if the FPS-Plus system fails, you will want to install this switch; . . . otherwise, you can just wire the flap motor outputs of the FPS-Plus or FPS-Plus-nt directly to the flap motor.

Method #1

The manual flap switch should operate as two independent switches (up/down). Refer to the FPS-Plus or FPS-Plus-nt schematic diagram. The schematic depicts them in one enclosure. Both switches should be a Single Pole, Double Throw, ON-NONE (ON), momentary, 3 position switch. They should be capable of switching your full flap motor currents. Wire them to the schematic.

Compatible Stick Grips & Panel Switches:

The RayAllen RS2 and ROS-4 switches and their stick grips are all compatible with this switching methodology. They all provide two separate switches inside that you can wire together to get this type of switching operation. You won't have to purchase any other components if your motor currents are lower than the maximum allowable switch currents for their products.

If your motor currents are higher than your switches will take, you will need to purchase our relay board (Model: 1RY1) and use a Single Pole, Double Throw, (ON)-OFF-(ON), momentary, 3 position switch to drive it. Refer to our "Switching Options Diagram" for more details.

Method #2

If you do not have two independent switches (up/down) on your stick grip or instrument panel, . . you may use a single switch and one of our relay boards (Model: 1RY1). Our relay board will convert the single switch operation to the double switch operation mentioned in Method #1. This switch driving the relay board should be a Single Pole, Double Throw, (ON)-OFF-(ON), momentary, 3 position switch. Refer to our "Switching Options Diagram" for more details. You can purchase this type of switch most anywhere. The current or voltage rating of the switch does not matter since it switched low currents.

Compatible Stick Grips & Panel Switches:

The Infinity Aerospace stick grip has a Single Pole, Double Throw, (ON)-OFF-(ON), momentary, 3 position switch in it. This stick can be made compatible with this switching method. If you need this type of switch for your instrument panel, you can purchase it almost anywhere. This type of switch is very common.

You need a FPS-Plus ON/OFF Switch (OPTIONAL)

This switch is optional. During normal operation, there is really no need to use the on/off switch to turn the FPS-Plus on and off. We leave ours on 100% of the time, . . BUT . . if you want to be able to turn the FPS-Plus on and off, and you also want to have your manual Flap Switch function as a back-up in case of an FPS-Plus failure, you'll want to install this switch. If you do not want to have a manual flap switch back-up, and you simply want to turn the FPS-Plus system off, you can use a simple Single Pole, Double Throw, ON-NONE-ON switch or circuit breaker switch.

If you want to have a emergency back-up, please wire this switch exactly like the diagram. If you do not, your Manual Flap switch may not function for all types of system failures. This switch can be any switch that is capable of carrying your maximum flap motor current. The switch is a simple Single Pole, Double Throw, ON-NONE-ON switch that you can purchase most anywhere. Please refer to SW1 of our "Switching Options Diagram" for switching operation of this switch if you are unfamiliar with it.

You need a Position Sensor

We recommend the RayAllen Company's POS-12. It is a 5K Ohm potentiometer. You may however use any linear pot that has a resistance of 5K, 10K, or 20K Ohms. You can also use the RayAllen POS-5 and POS7, but the total wiper movement of these pots is shorter than the POS12. The POS-12 may have a bit more resolution and some additional advantages. Using the POS-12 may help eliminate a bit of mechanical slop in the connection to your flap mechanism and improve the accuracy of the position signal a bit. I guess our general rule would be, the greater potentiometer wiper travel of the pot, the better!

Switching Options

There are many switching schemes utilized in aircraft systems. If you do not see a switching methodology that fits your aircraft while installing the FPS-Plus or FPS-Plus-nt, please be sure to check out Aircraft Extras, Inc.'s relay boards (Model: 1RY1). There you will find many switching options that can be adapted to the FPS-Plus and other control systems for your aircraft. You will find several schematic diagrams detailing several switching methods used for aircraft systems.

Protection against accidental Flap Deployment at High Airspeeds

(an OPTIONAL add-on)

Since the introduction of automatic flap controllers for the experimental aircraft market, some pilots have accidentally bumped their flap down switch during high speed flight. This initiates a flap down movement when you need it least, above the white arc! Granted your flap controller may only move the flaps down one notch of flaps, but if you do not want this to happen, we have an answer.

Aircraft Extras has developed a device that you can use with almost any flap controller that eliminates this problem. When our relay board is used with our airspeed switch, you can protect you flaps from being actuated in the downward direction when your airspeed is too high. We provide the end user with easy connection diagrams for several different systems. Refer to our Model ASRY1.

Automatic Elevator Trim Motor Speed Adjust at different airspeeds

(an OPTIONAL add-on)

Since the introduction of electric elevator trim adjustment, many have complained that the adjustment speed of the elevator trim motors at high airspeeds is too fast. This makes it difficult to adjust the elevator trim and find a good stable trim position at higher airspeeds. It is really desired to have a fast elevator trim motor speed at lower airspeeds, and a lower trim motor speed at higher airspeeds. Aircraft Extras has an answer for this problem.

When our relay board is used with our airspeed switch, it eliminates this problem. Using it, you will have two elevator trim motor speeds, fast for slower airspeeds, and slower for high airspeeds. Refer to our Model ASRY1.

In Summary

We hope this wasn't too much information to scare off the non-electrical builders! The FPS-Plus and FPS-Plus-nt system is really simple when you FIRST decide what stick grips, panel switches, and sensors you want to use. If we can help you further or direct you toward other reference material, please let us know.

PLEASE fly safe, and have fun!

Switching Options & Background knowledge

SW1

Single Pole, Double Throw
ON-NONE-ON
2 Positions

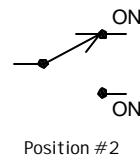
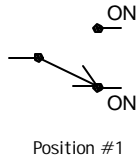

SW2

Single Pole, Double Throw
(ON)-OFF-(ON)
3 Positions
(Switch is a momentary on switch)

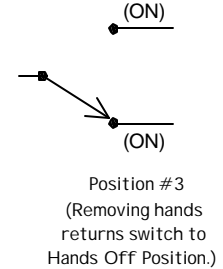
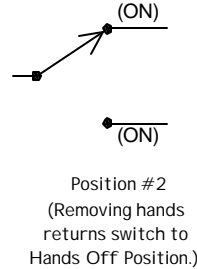
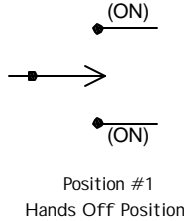

This diagram depicts 2 switches in one housing.
Each switch is operated independently.
Each switch is a Single Pole, Double Throw,
ON-NONE-(ON), 2 Position switch.
(Each switch is a spring loaded "momentary on" switch)
The RayAllen Company stick grips and their RS2 and
RS2-5 panel switches can be wired in this manner.

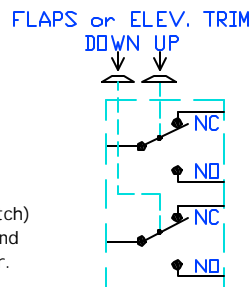

Figure 1

NOTE:

IF YOU DO NOT HAVE 2 INDEPENDENT SWITCHES THAT YOU CAN WIRE LIKE FIGURE #1, YOU CAN OBTAIN THIS SAME SWITCHING ACTION BY USING A STANDARD SWITCH (SW2 as pictured above) WITH OUR RELAY BOARD (1RY1). SEE THE DIAGRAM ABOVE. THE RELAY BOARD ARCING PROTECTION CIRCUITRY WAS OMITTED FROM THIS DIAGRAM FOR SIMPLICITY. IF YOU DESIRE TO ADD A SWITCH FOR THE CO-PILOT OR TO ANOTHER PANEL LOCATION, YOU MAY ACHIEVE THIS BY SIMPLY PARALLELING SEVERAL SWITCHES FOR SW2.

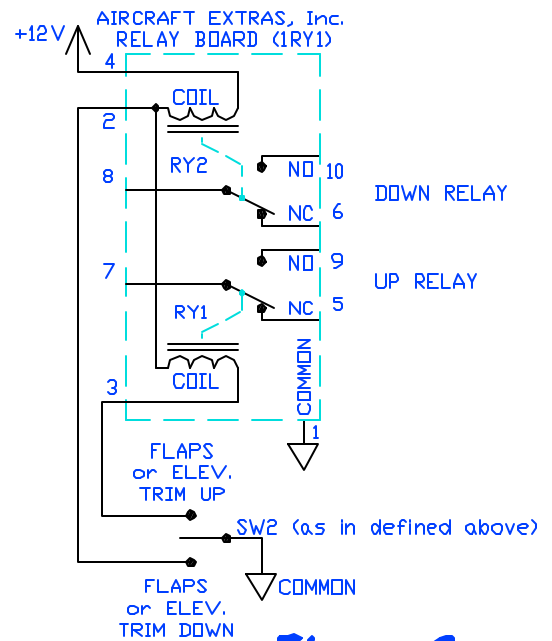

Figure 2

GENERAL NOTES:

- 1.) FOR SWITCHES, (ON) MEANS "ON MOMENTARY" OR SPRING LOADED.
- 2.) FOR RELAYS, NO = NORMALLY OPEN, NC = NORMALLY CLOSED WHEN DE-ENERGIZED.
- 3.) ALL RELAYS AND SWITCHES ARE SHOWN IN THE DE-ENERGIZED STATE.

**Aircraft
Extras**

SWITCHING OPTIONS DIAGRAM
Rev. - New, 1/18/06
AIRCRAFT EXTRAS, INC.